

55X45-K-2.0



AUSTROFLAMM



www.austroflamm.com

55X45-K-2.0



AUSTROFLAMM

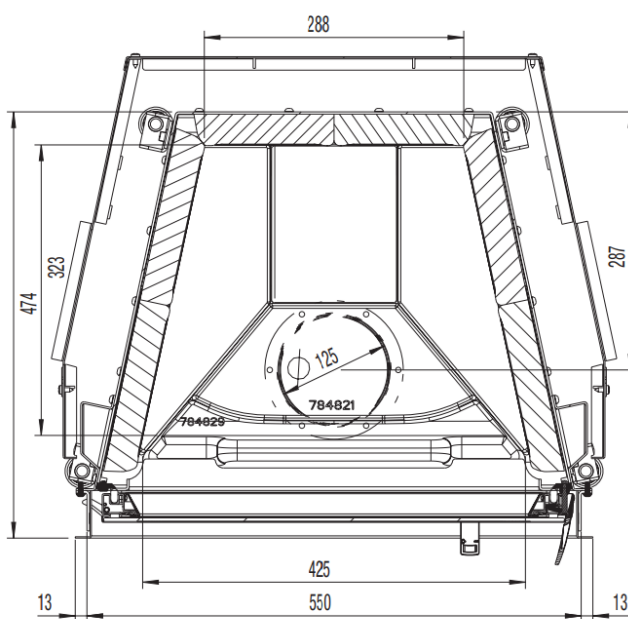
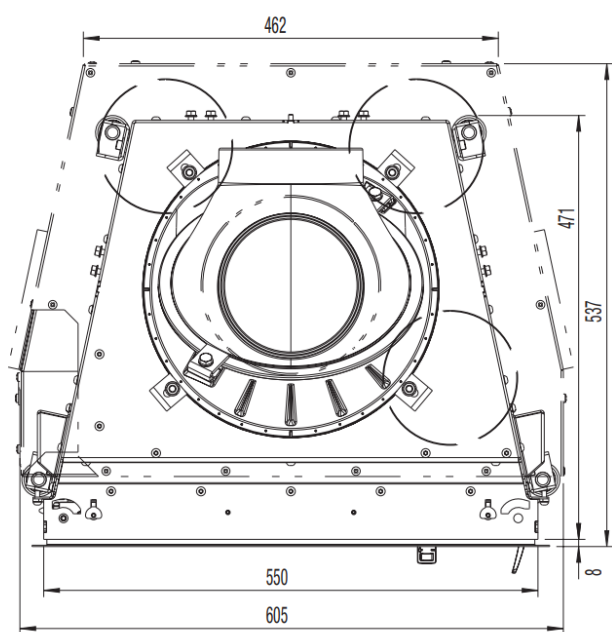
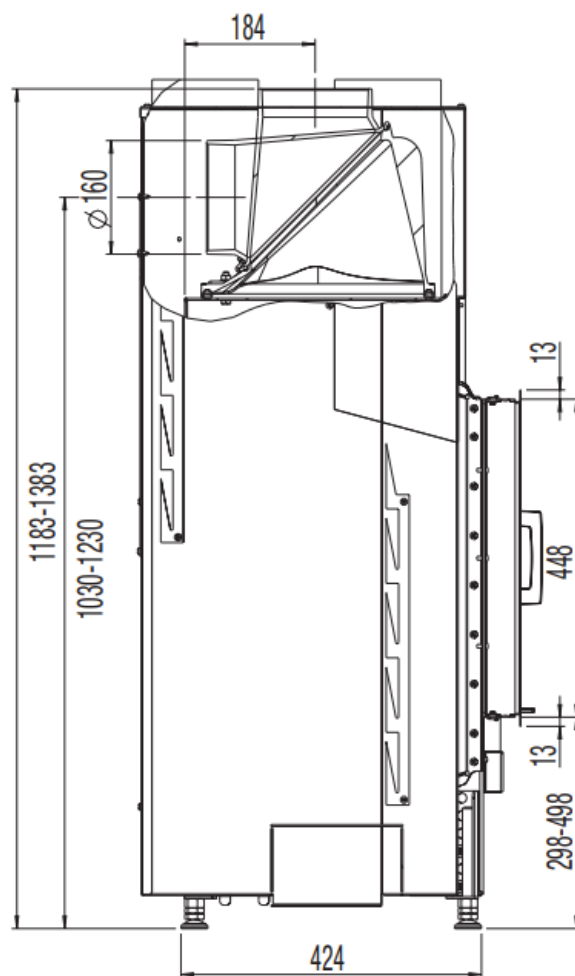
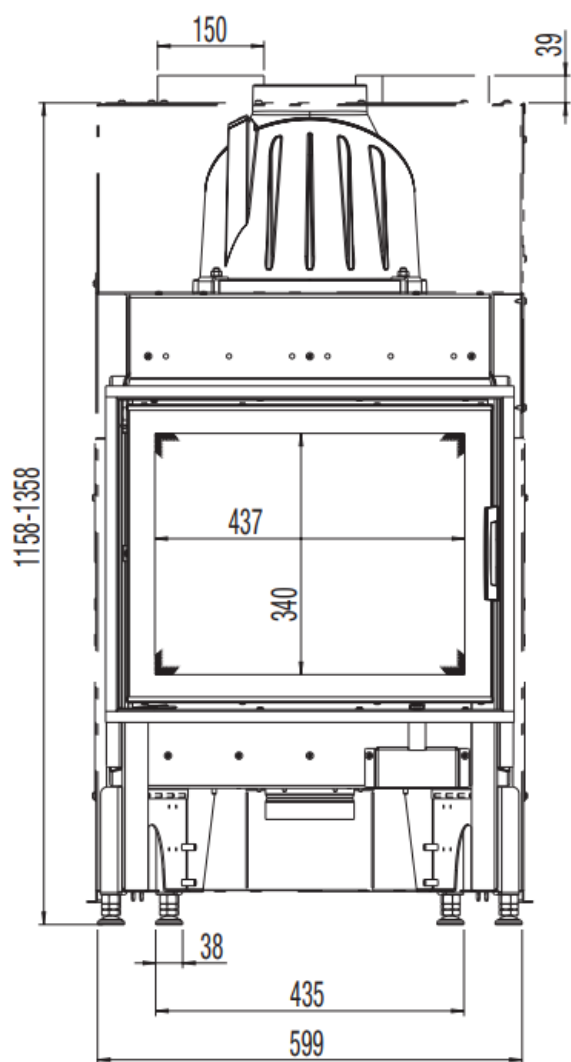

o standard

Z Accessories

- not available

DIMENSIONS AND WEIGHTS

Height [mm]	1183-1383
Width [mm]	605
Depth [mm]	471
Weight [kg]	101
Width (body installation dimension) [mm]	550
Door frame, height [mm]	450
Flue pipe outlet, diameter [mm]	160
Insulation layer thicknesses to the installation floor [mm] (Promasil 950 KS)	60
Insulation layer thicknesses lateral / rear [mm] (Promasil 950 KS)	90
Insulation layer thicknesses to the ceiling [mm] (Promasil 950 KS)	90
Ceramic flues - max. length [m]	3.5

HEAT OUTPUT

Nominal heat efficiency [kW] lt. EN test EN 13229	7
Heat output, minimum [kW] / Maximum heat output [kW]	3.5-9
Energy efficiency category	A+
Circulating air cross-section without / with metal secondary heating surface [cm ²]	700/1100

FEATURES

Hinged doors	yes
Double pane	x

DATA FOR THE CHIMNEY SWEEP

Total flue gas flow [g/s]	5.85
Flue gas temperature [°C]	275
Minimum feed pressure at nominal heat efficiency [Pa]	12